

Belts for the Marble and Ceramic Industries





Knowing Your Production Processes

When it comes to the Marble and Ceramic industries, it's the belts that drive production.

Ammeraal Beltech works closely with key OEMs around the world to develop durable and precise performance belting solutions for the entire range of production applications of both natural and synthetic stone processing, including:

- block cutting and splitting
- calibration and slab polishing
- chamfering and edge polishing
- mixing and dosing raw materials
- forming engineered slabs in the production of synthetic materials

Ammeraal Beltech customers know that the investment the company has always made in innovation and growth will keep their businesses at the forefront of new industry developments and bring them the benefits of a global belting industry company with strategically located manufacturing facilities for quick turnaround times. They are aware, too, of the exceptional international assistance network Ammeraal Beltech maintains to provide 24/7 service coverage and cut downtime to a minimum.

We offer a wide range of belting products. By choosing Ammeraal Beltech, you can not only reduce your supplier base, you will also have access to our worldwide network of industry and product specialists.

ONE STOP SHOP
belt

local stock
quick belt replacement
short delivery time
24/7 service





A Trusted Partner in the Marble and Ceramic Industries

Ammeraal Beltech works with OEMs and end users as partners, to provide conveyor and process belting solutions that can improve product quality, reduce maintenance times and lower manufacturing costs.

Innovative solutions to meet customer challenges:

Industry challenges	Ammeraal Beltech solutions – several hardnesses
<ul style="list-style-type: none"> • movement of the marble slab or ceramic product during polishing • product positioning • water accumulation • heavy loads • abrasive environment • high grip required • high coefficient of friction required • presence of mineral oils, hydrocarbons, and detergents 	<p>Soft, 46 – 55 ShA cover hardness PVC belts</p> <ul style="list-style-type: none"> • Very elastic and soft cover with a high coefficient of friction. • Large variety of profiles ensures the availability of the right belt for any application where a high grip is required.
	<p>55 ShA cover hardness PVC belts</p> <ul style="list-style-type: none"> • Specifically designed for marble, granite, ceramic polishing and gauging machines. • Bottom side fabric has a PU impregnation for a low coefficient of friction and protection against pollution. • High grip top side for stable polishing. • Usually feature a 4 ply high strength carcass. • Very low elongation. • High resistance to cutting. • Pattern structure for good water drainage.
	<p>74 ShA hardness PVC belts</p> <ul style="list-style-type: none"> • Good resistance to abrasion and cutting. • Suitable for conveying in the presence of mineral oils, hydrocarbons, and detergents. • Different cover hardnesses and profile designs.



Natural Stone Processes

Machinery	Materials	Products								
		FBLT054049	FBLT054050	SBMD000135	SBMD000137	SBMD000138	SBMD000114	SBMD000116	SBMD000117	SBMD000118
Block cutting machine	Marble	✓	✓							
	Granite	✓	✓							
Grinding machine	Marble						✓	✓		
	Granite							✓	✓	
	Gres/Ceramic									✓
Slab polishing machine	Marble			✓	✓					
	Granite					✓				
	Gres/Ceramic				✓					
Splitting machine	Marble							✓		
	Granite							✓		
Calibration and Polishing Machine	Marble			✓				✓	✓	✓
	Granite							✓	✓	✓
	Gres/Ceramic				✓					✓
Chamfering, Flaming and Bush-hammering machines	Marble					✓	✓			
	Granite					✓	✓			
Edge polishing machine	Marble			✓	✓					
	Granite			✓	✓					

This application/conveyor belts table does not claim to be complete; it's only a suggestion of potential solutions. Contact Ammeraal Beltech for more information.

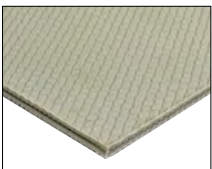

R6 structure
Snake Skin

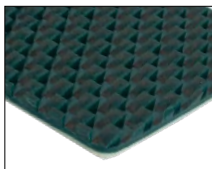

R7 structure
Staggered Saw
Tooth 1

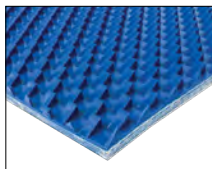

R8 structure
Staggered Saw
Tooth 2

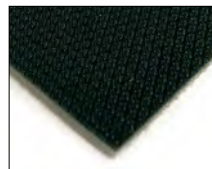

R14 structure
Light Fabric

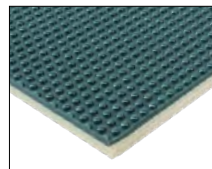

R19 structure
Nipple Top

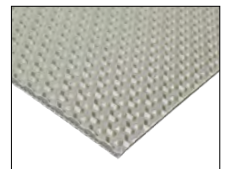

R20 structure
Y Structure



Block Cutting Machine Grinding Machine

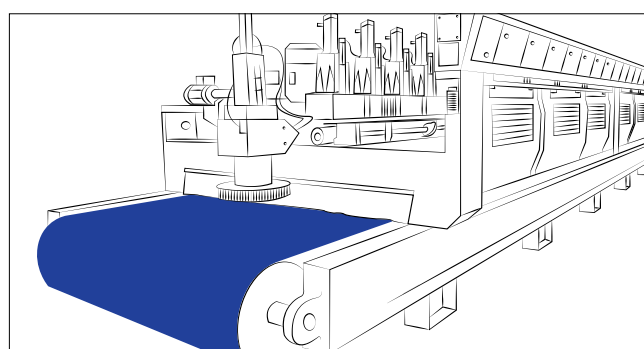
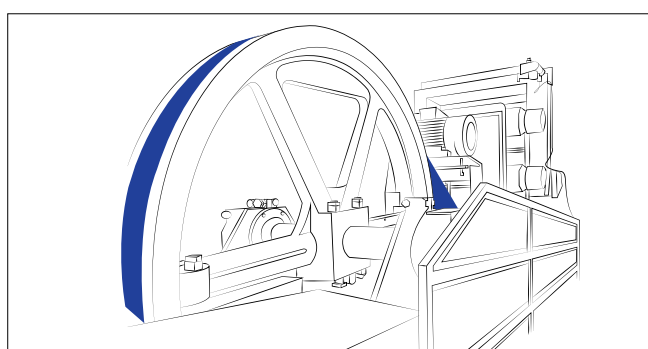

FBLT054049 & FBLT054050

LT S18 C & LT S27 C

Leather flat belt with fabric top surface. Medium friction can handle peak loads and best suited for lateral movement.

The correct belt selection is crucial to ensure the optimal power transmission, therefore a correct calculation is required. Please ask our specialists.



SBMD000116

Flexam EF 40/3 01+R19 Dark Green

PVC conveyor belt, 74 ShA, 3 plies, R19 top cover profile, resistant to mineral oils, hydrocarbons and detergents. Good abrasion resistance.

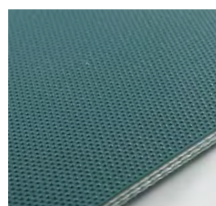

SBMD000117

Flexam EF 50/3 01+R19 Dark Green

PVC conveyor belt, 74 ShA, 3 plies. Thin hemispherical R19 profile allows the best adhesion to the workpiece. Good abrasion resistance.

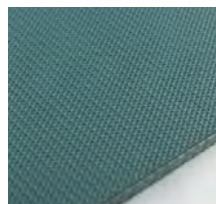

SBMD000118

Flexam EF 70/4 00+R6 Dark Green

PVC conveyor belt, 74 ShA, 4 plies, with R6 surface design. This rhomboidal profile is especially designed to assure maximum adhesion of the conveyed product and drainage of water.

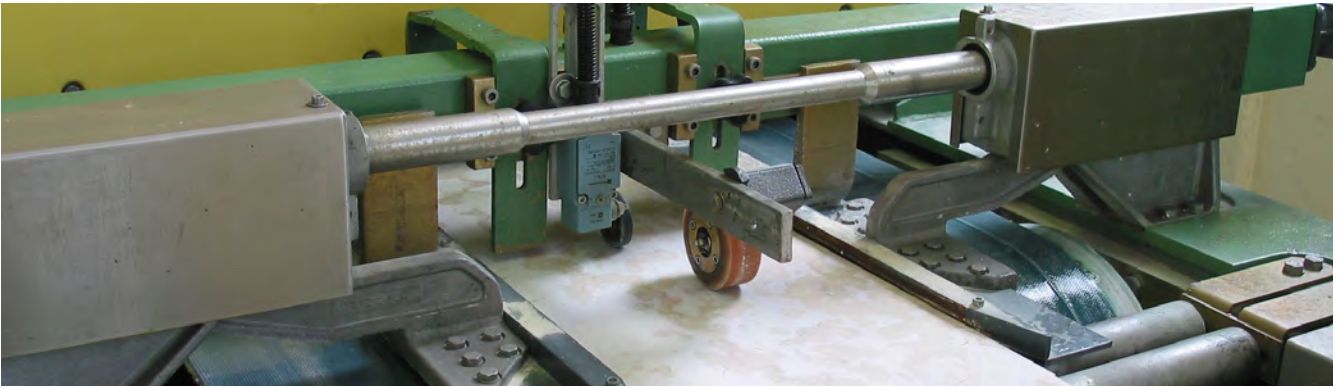

Slab Polishing Machine

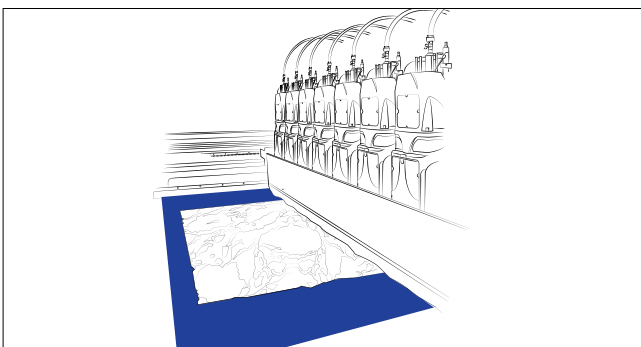

SBMD000135

Flexam EF 50/3 01+R19 Dark Green
PVC conveyor belt, 46 ShA, 3 plies. Its very flexible cover and R19 structure surface guarantee both grip and drainage of water.



SBMD000137

Flexam EF 70/4 00+R20 Dark Blue
Very strong PVC conveyor belt, 55 ShA, 4 plies. High stability of the products conveyed.

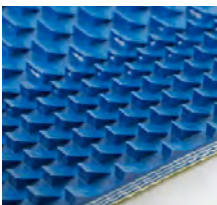

SBMD000138

Flexam EF 70/4 00+R8 Dark Blue
PVC conveyor belt, 55 ShA, 4 plies. High profile with tooth-saw design, being an evolution of our classical profile, allows maximum stability of the marble and granite slabs also for thin and slightly bulged slabs.

Splitting Machine

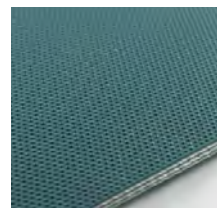
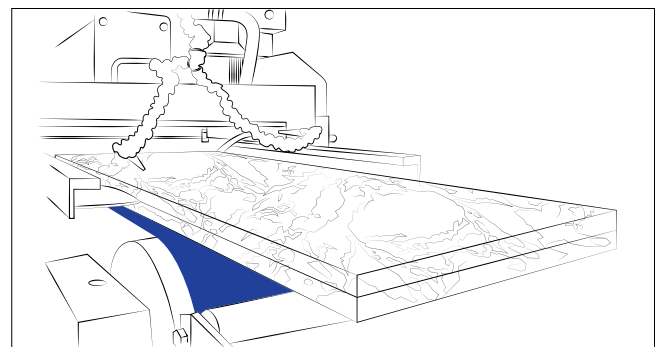

SBMD000117

Flexam EF 50/3 01+R19 Dark Green
PVC conveyor belt, 74 ShA, 3 plies. Thin, hemispherical profile allows the best adhesion to the workpiece. Good abrasion resistance.



Calibration and Polishing Machine

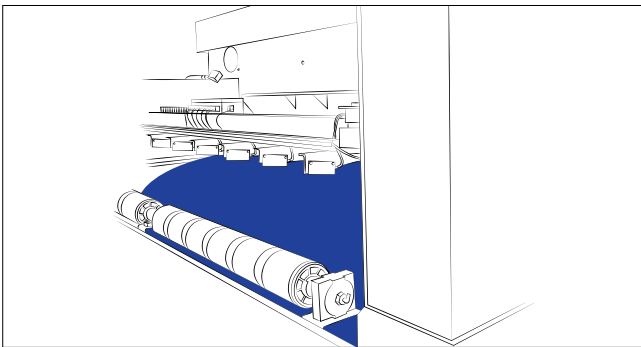

SBMD000116

Flexam EF 40/3 01+R19 Dark Green
PVC conveyor belt, 74 ShA, 3 plies, R19 top cover structure, resistant to mineral oils, hydrocarbons and detergents.



SBMD000135

Flexam EF 50/3 01+R19 Dark Green
PVC conveyor belt, 46 ShA, 3 plies. Its very flexible cover and R19 structure surface guarantee both grip and drainage of water.

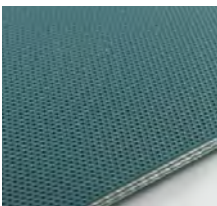

SBMD000117

Flexam EF 50/3 01+R19 Dark Green
PVC conveyor belt, 74 ShA, 3 plies. Thin hemispherical profile allows the best adhesion to the workpiece. Good abrasion resistance.

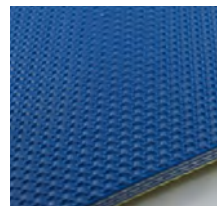

SBMD000137

Flexam EF 70/4 00+R20 Dark Blue
Very strong 4 plies PVC conveyor belt, 55 ShA. High stability of the products conveyed.



SBMD000118

Flexam EF 70/4 00+R6 Dark Green
PVC conveyor belt, 74 ShA with R6 surface design. This rhomboidal profile is especially designed to assure maximum adhesion of the conveyed product and drainage of water.



Chamfering Machine

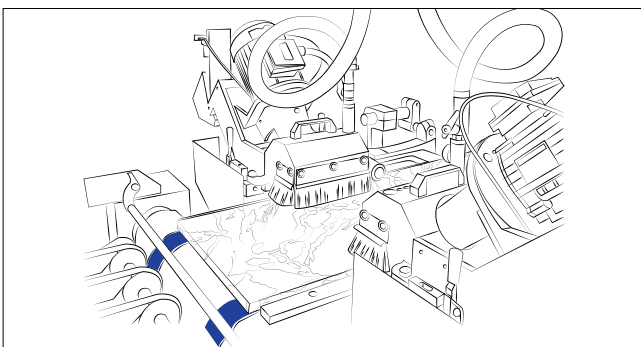

Edge Polishing Machine

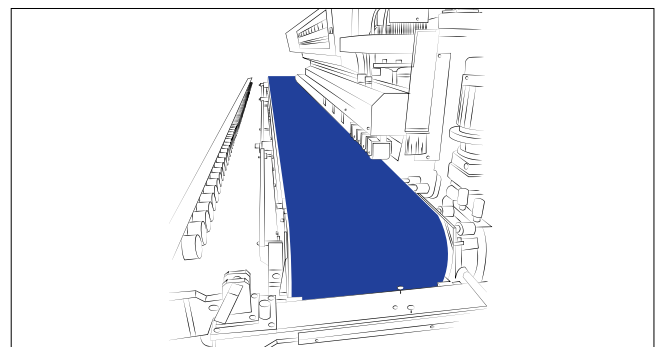

SBMD000114

Flexam EM 16/3 0+R19 Dark Green AS
PVC conveyor belt, 74 ShA, 3 plies, R19 cover surface; good resistance to abrasion.

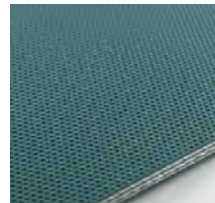

SBMD000135

Flexam EF 50/3 01+R19 Dark Green
PVC conveyor belt, 46 ShA, 3 plies. Its very flexible cover and R19 structure surface guarantee both grip and drainage of water.



SBMD000138

Flexam EF 70/4 00+R8 Dark Blue
PVC conveyor belt, 55 ShA, 4 plies. High profile with tooth-saw design, being an evolution of our classical profile, allows maximum stability of the marble and granite slabs also for thin and slightly bulged slabs.

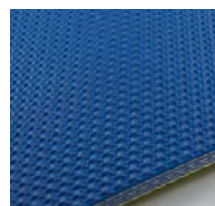

SBMD000137

Flexam EF 70/4 00+R20 Dark Blue
Very strong PVC conveyor belt, 55 ShA, 4 plies. High stability of the products conveyed.



Synthetic Process

Machinery	Products					
	SBMD000075	SBPO514361	SBPE510440	SBMD000062	SBMD000205	SBFL570180
Mixture and Dosing	✓	✓	✓			
Engineered stone press – slab forming				✓	✓	
Conveying of engineered stone powders						✓

Mixture and Dosing Machine

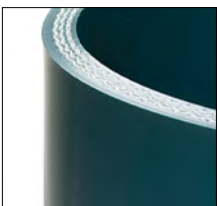
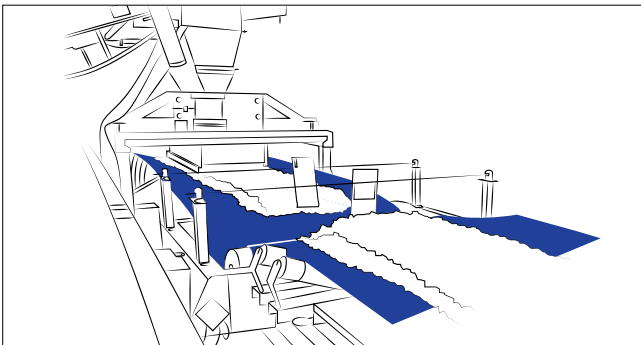

SBMD000075

Excon EF 30/3 07+20 Dark Green AS FG FR
Flexible PVC conveyor belt, 75 ShA, 3 plies, oil and fat resistant. Antistatic properties, tear resistance according to DIN 53363 and flame retardant according to ISO 340.



SBPE510440

Peflex ESM 15/3 0+02 transparent M1 AS FG NL
Polyolefin conveyor belt, 92 ShA cover hardness. Matt cover, 3 plies.



SBPO514361

Poliflex ESM 10/2 0+02 transparent M1 AS FG NL
Polyolefin conveyor belt, 92 ShA cover hardness. Matt cover, 2 plies.

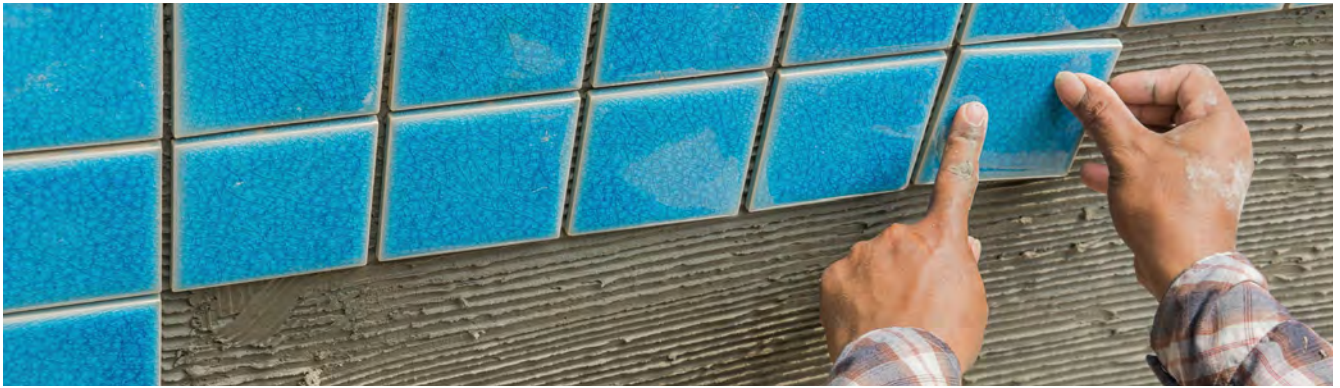

Engineered Stone Slab Forming

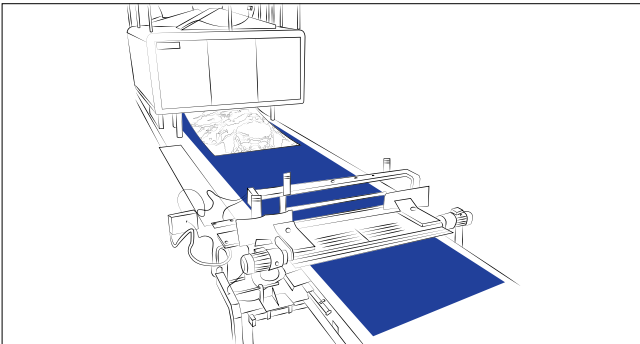

SBMD000205

Flexam EF 45/2 R14+R14 black
Flexible conveyor belt, 2 plies, perfect vacuum sealed, extraordinary resistance to abrasion from vibration process, very good temperature and solvents resistance.

Conveying of Engineered Stone Powders

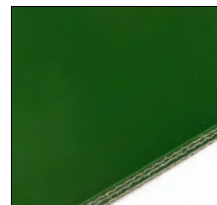
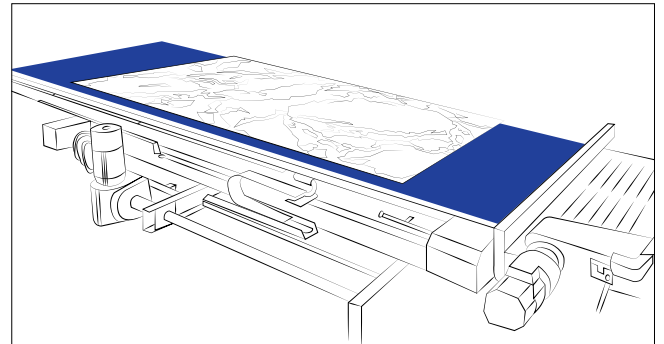

SBFL570180

Flexam EM 15/3 0+10 Green AS FG
Flexible PVC conveyor belt, 72 ShA, 3 plies, oil and fat resistant.

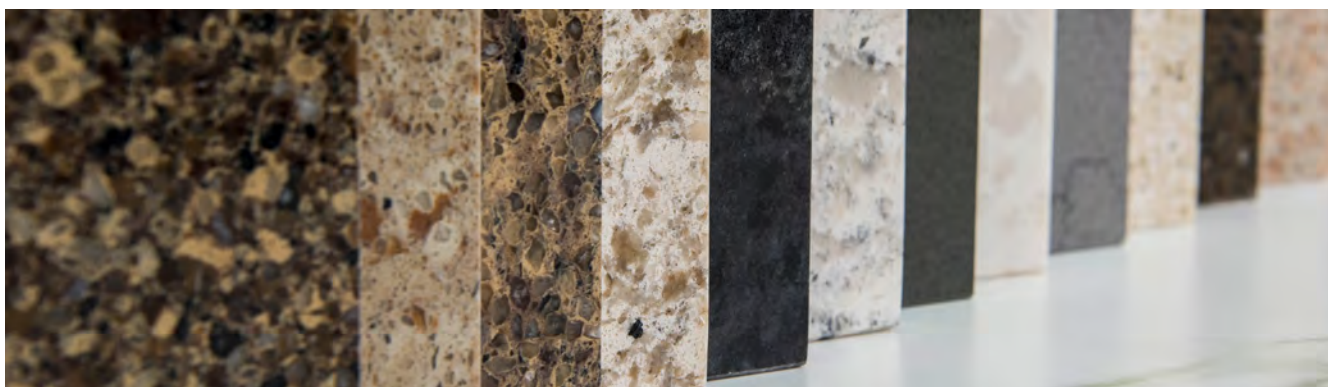

Just-in-time delivery

At Ammeraal Beltech, we understand the importance of keeping your business running because we know just how costly and disruptive downtime can be.

A solid combination of geographical coverage, industry-segment knowledge and product management is the foundation of our innovative and service-oriented organisation.

Ammeraal Beltech has a Global Sales and Service Team and a Partner Network ready to help round the clock!



28 fully owned operating companies



Excellent advice, products, fabrication and service

- Ammeraal Beltech offers a wide range of belting solutions and accessories to help you improve processes to secure a seamless operation.
- Skilled personnel are on call to install or repair belts, using professional equipment that is suitable for production plants.
- Most orders can be dispatched directly from stock.

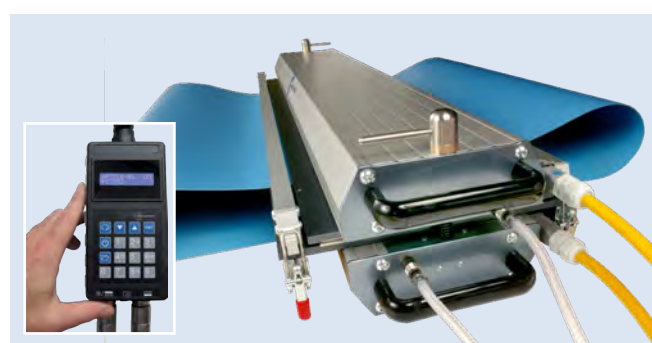

Quick, easy and precise belt splicing

With our expanded Maestro splice equipment range, Ammeraal Beltech has taken an important step forward in the critical areas of splice quality, speed, and precision.

Our new compact, hand-held, computerised splicing press control-box is the perfect complement to our Maestro press, and makes precise splicing as easy as 1-2-3.

Find out more:
www.ammeraalbeltech.com

Local Contacts

... and 150 more service contact points
at ammeraalbeltech.com

Argentina

T +54 11 4218 2906
info-ar@ammeraalbeltech.com

Australia

T +61 3 8780 6000
info-au@ammeraalbeltech.com

Austria

T +43 171728 133
info-de@ammeraalbeltech.com

Belgium

T +32 2 466 03 00
info-be@ammeraalbeltech.com

Canada

T +1 905 890 1311
info-ca@ammeraalbeltech.com

Chile

T +56 2 233 12900
info-cl@ammeraalbeltech.com

China

T +86 512 8287 2709
info-cn@ammeraalbeltech.com

Colombia

T +57 893 9890
info-co@ammeraalbeltech.com

Czech Republic

T +420 567 117 211
info-cz@ammeraalbeltech.com

Denmark

T + 45 7572 3100
info-dk@ammeraalbeltech.com

Finland

T +358 207 911 400
info-fi@ammeraalbeltech.com

France

T +33 3 20 90 36 00
info-fr@ammeraalbeltech.com

Germany

T +49 4152 937-0
info-de@ammeraalbeltech.com

Hungary

T +36 30 311 6099
info-hu@ammeraalbeltech.com

India

T +91 44 265 34 244
info-in@ammeraalbeltech.com

Israel

T +972 4 6371485
info-il@ammeraalbeltech.com

Italy

T +39 051 660 60 06
info-it@ammeraalbeltech.com

Japan

T +81 52 433 7400
info-jp@ammeraalbeltech.com

Luxembourg

T +352 26 48 38 56
info-lu@ammeraalbeltech.com

Malaysia

T +60 3 806 188 49
info-my@ammeraalbeltech.com

Mexico

T +52 55 5341 8131
info-mx@ammeraalbeltech.com

Netherlands

T +31 72 57 51212
info-nl@ammeraalbeltech.com

Poland

T +48 32 44 77 179
info-pl@ammeraalbeltech.com

Portugal

T +351 22 947 94 40
info-pt@ammeraalbeltech.com

Singapore

T +65 62739767
info-sg@ammeraalbeltech.com

Slovakia

T +421 2 55648541-2
info-sk@ammeraalbeltech.com

South Korea

T +82 31 448 3613-7
info-kr@ammeraalbeltech.com

Spain

T +34 93 718 3054
info-es@ammeraalbeltech.com

Sweden

T +46 44 780 3010
info-se@ammeraalbeltech.com

Switzerland

T +41 55 2253 535
info-ch@ammeraalbeltech.com

Thailand

T +66 2 902 2604-13
info-th@ammeraalbeltech.com

Turkey

T +90 232 877 0700
info-tr@ammeraalbeltech.com

United Kingdom

T +44 1992 500550
info-uk@ammeraalbeltech.com

United States

T +1 847 673 6720
info-us@ammeraalbeltech.com

Vietnam

T +84 8 376 562 05
info-vn@ammeraalbeltech.com

**Expert advice, quality solutions
and local service
for all your belting needs**

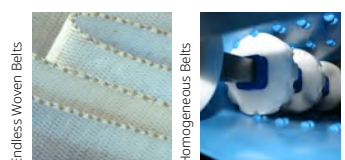
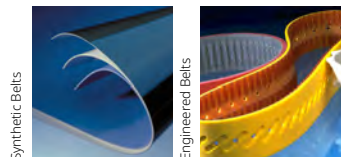

General contact information:

Ammeraal Beltech
P.O. Box 38
1700 AA Heerhugowaard
The Netherlands

T +31 (0)72 575 1212
info@ammeraalbeltech.com

ammera.com